

-  T. +39 (0)883535781
-  info@ermetika.it
-  www.ermetika.it
-  www.youtube.com/ermetikasrl

Ermetika © all rights reserved. The reproduction and total or partial use, in any form and/or with any means, of the documentation is allowed to nobody without a written permission by Ermetika Srl.

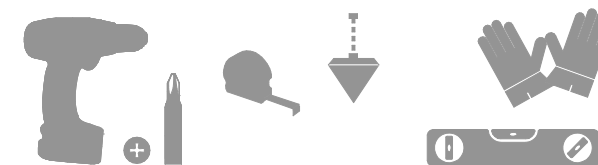





ATTREZZATURA - TOOLS - OUTILS - HERRAJES

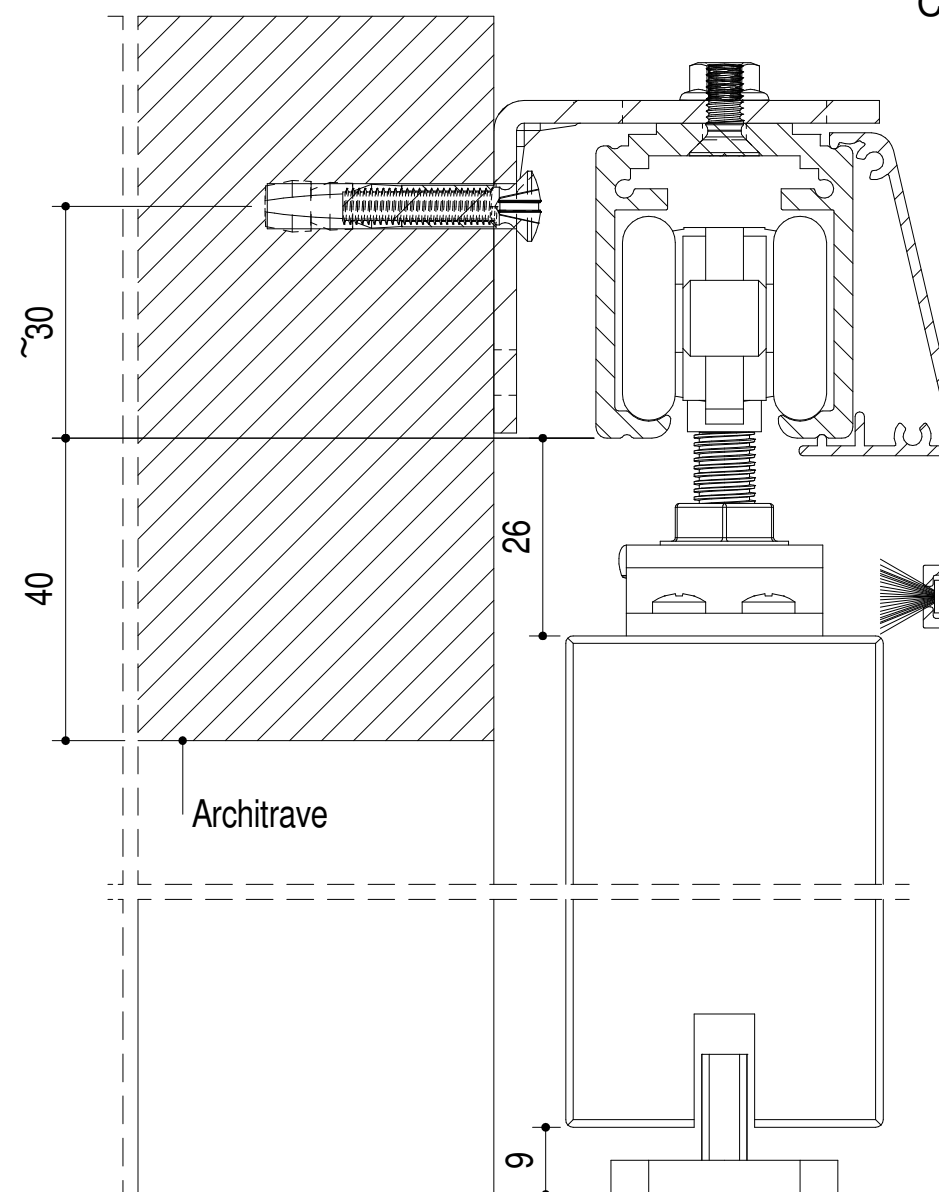

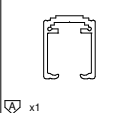
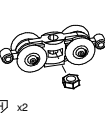
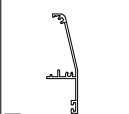
CONTENUTO KIT | CONTENTS

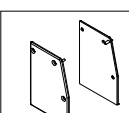
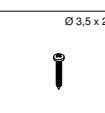
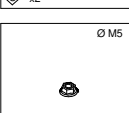
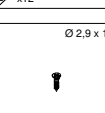

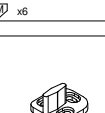
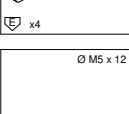
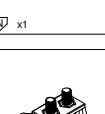
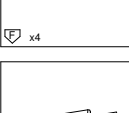
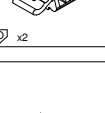
 x1	 x2
 x1	 x2
 x2	 x12
 x4	 x6
 x4	 x1
 x4	 x2
 x2	 x1

ISTRUZIONE MONTAGGIO BINARIO ESTERNO MURO
 WALL MOUNTED TRACK SET UP INSTRUCTION
 INSTRUCTION DE MONTAGE RAIL EN APPLIQUE
 INSTRUCCIONES DE MONTAJE GUIA A PARED

